

DESCRIPTION -  
XLMTV-610SA WITH DRINGS-CHOCKS

DRAWN BY - JAH

DATE - 6/13/19

THIS DOCUMENT AND THE CONCEPTS INCORPORATED IS THE PROPERTY OF UNITED TRAILERS INC. AND IS NOT TO BE USED IN WHOLE OR IN PART FOR ANY OTHER PROJECT WITHOUT WRITTEN PERMISSION OF UNITED TRAILERS INC..

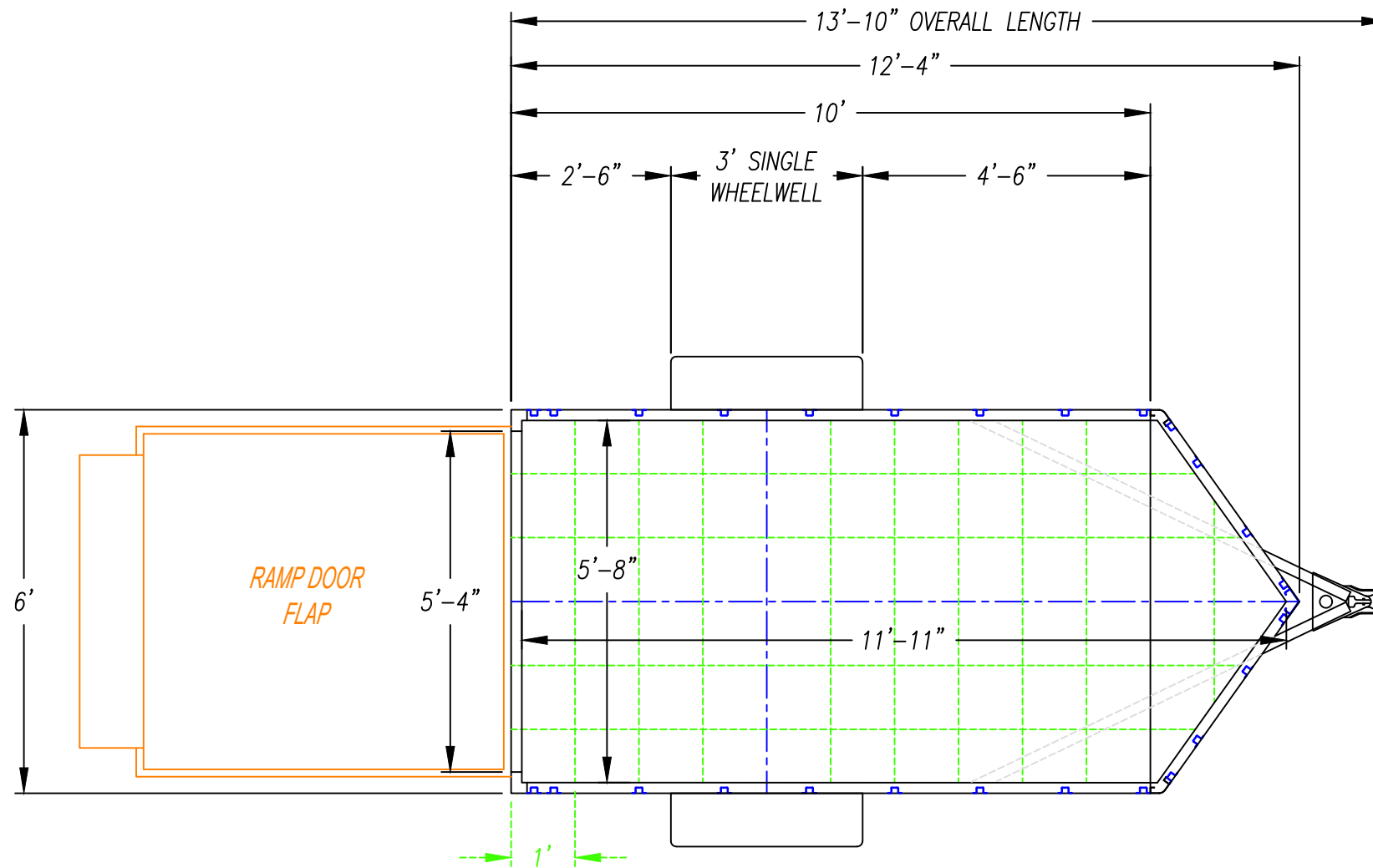

DESCRIPTION -  
XLMTV-610SA WITH NO DRINGS-CHOCKS

DRAWN BY - JAH

DATE - 6/13/19

THIS DOCUMENT AND THE CONCEPTS INCORPORATED IS THE PROPERTY OF UNITED TRAILERS INC. AND IS NOT TO BE USED IN WHOLE OR IN PART FOR ANY OTHER PROJECT WITHOUT WRITTEN PERMISSION OF UNITED TRAILERS INC..

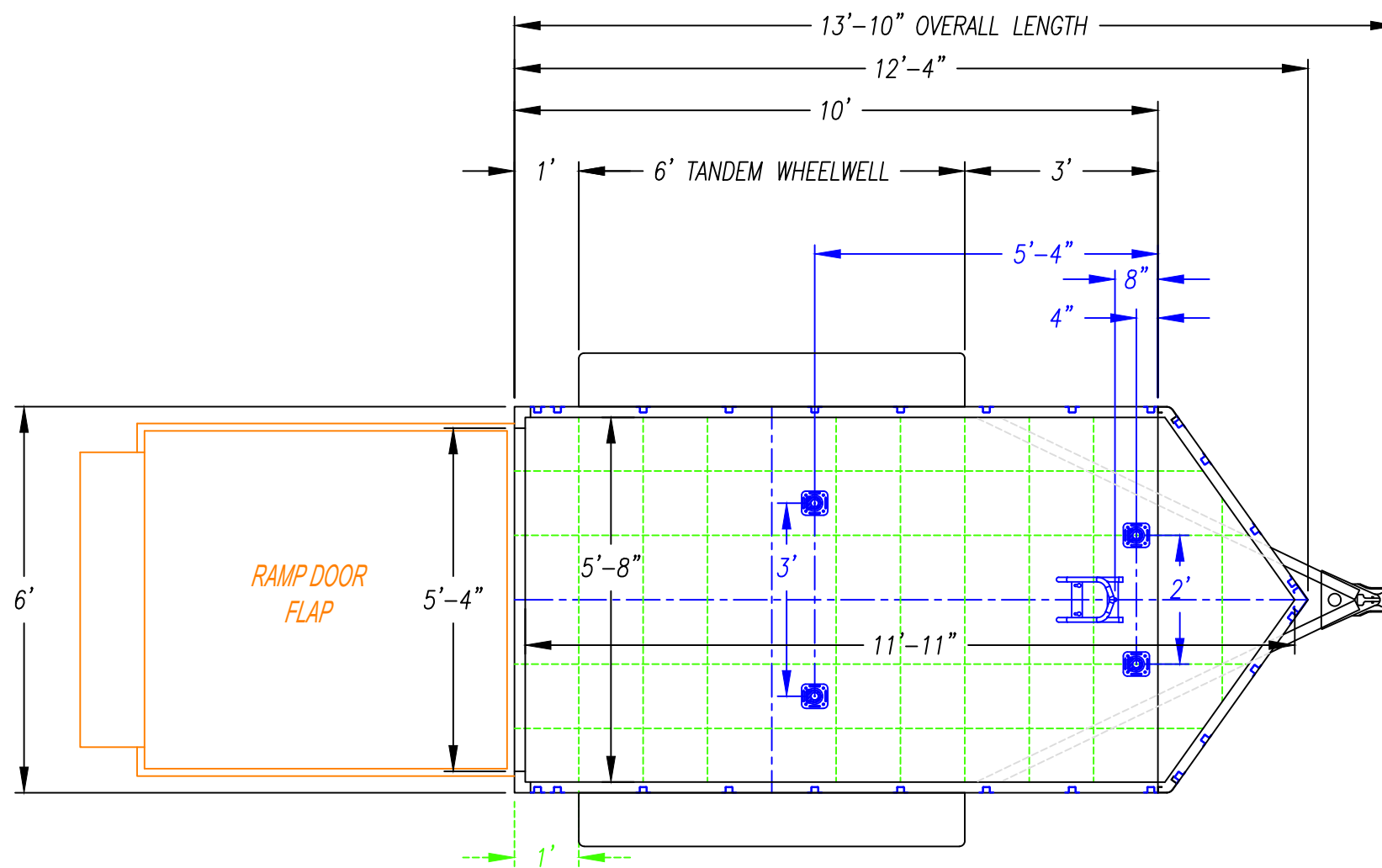

DESCRIPTION -  
XLMTV-610TA WITH DRINGS-CHOCKS

DRAWN BY - JAH

DATE - 6/13/19

THIS DOCUMENT AND THE CONCEPTS INCORPORATED IS THE PROPERTY OF UNITED TRAILERS INC. AND IS NOT TO BE USED IN WHOLE OR IN PART FOR ANY OTHER PROJECT WITHOUT WRITTEN PERMISSION OF UNITED TRAILERS INC..

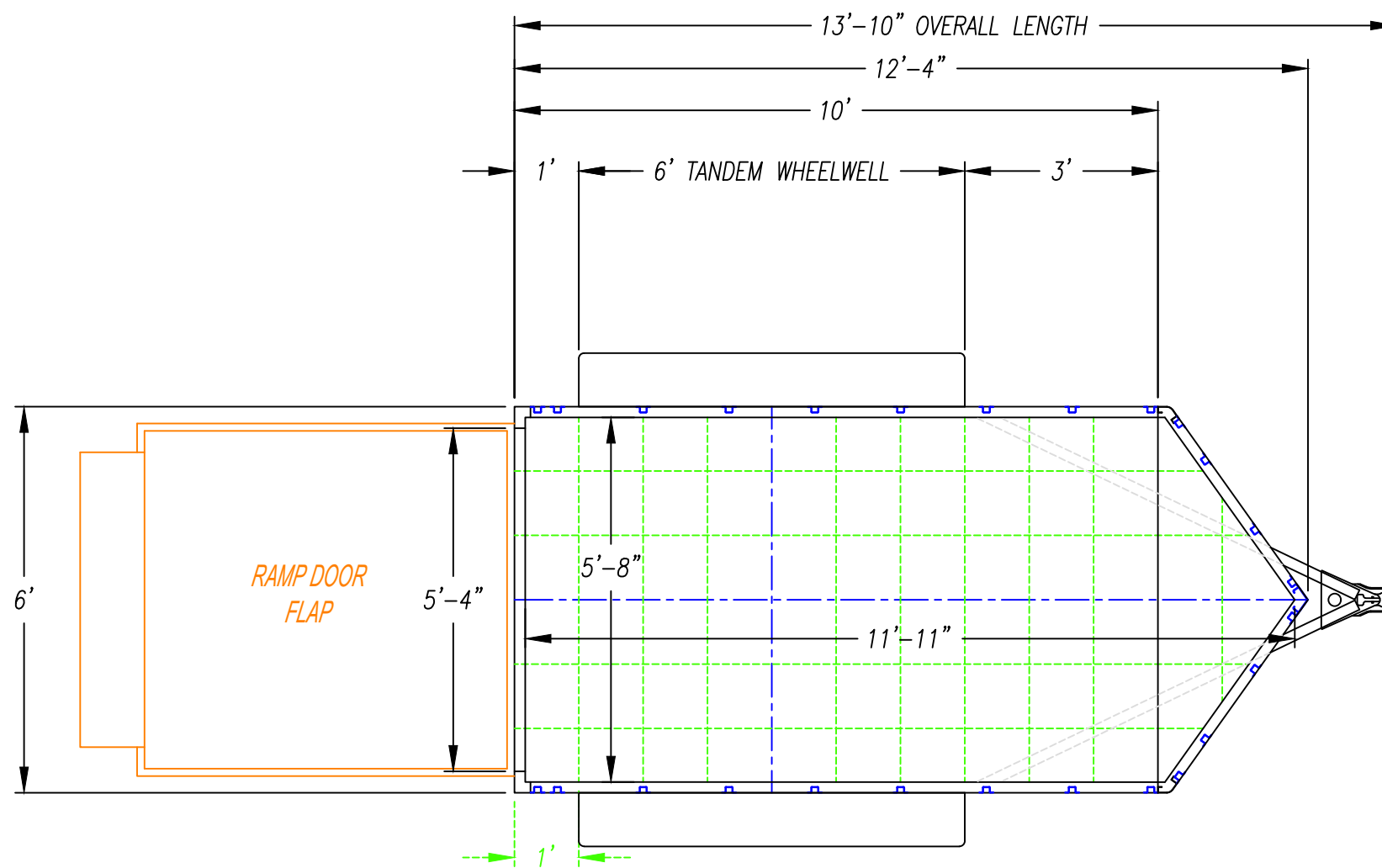

DESCRIPTION -  
XLMTV-610TA WITH NO DRINGS-CHOCKS

DRAWN BY - JAH

DATE - 6/13/19

THIS DOCUMENT AND THE CONCEPTS INCORPORATED IS THE PROPERTY OF UNITED TRAILERS INC. AND IS NOT TO BE USED IN WHOLE OR IN PART FOR ANY OTHER PROJECT WITHOUT WRITTEN PERMISSION OF UNITED TRAILERS INC..

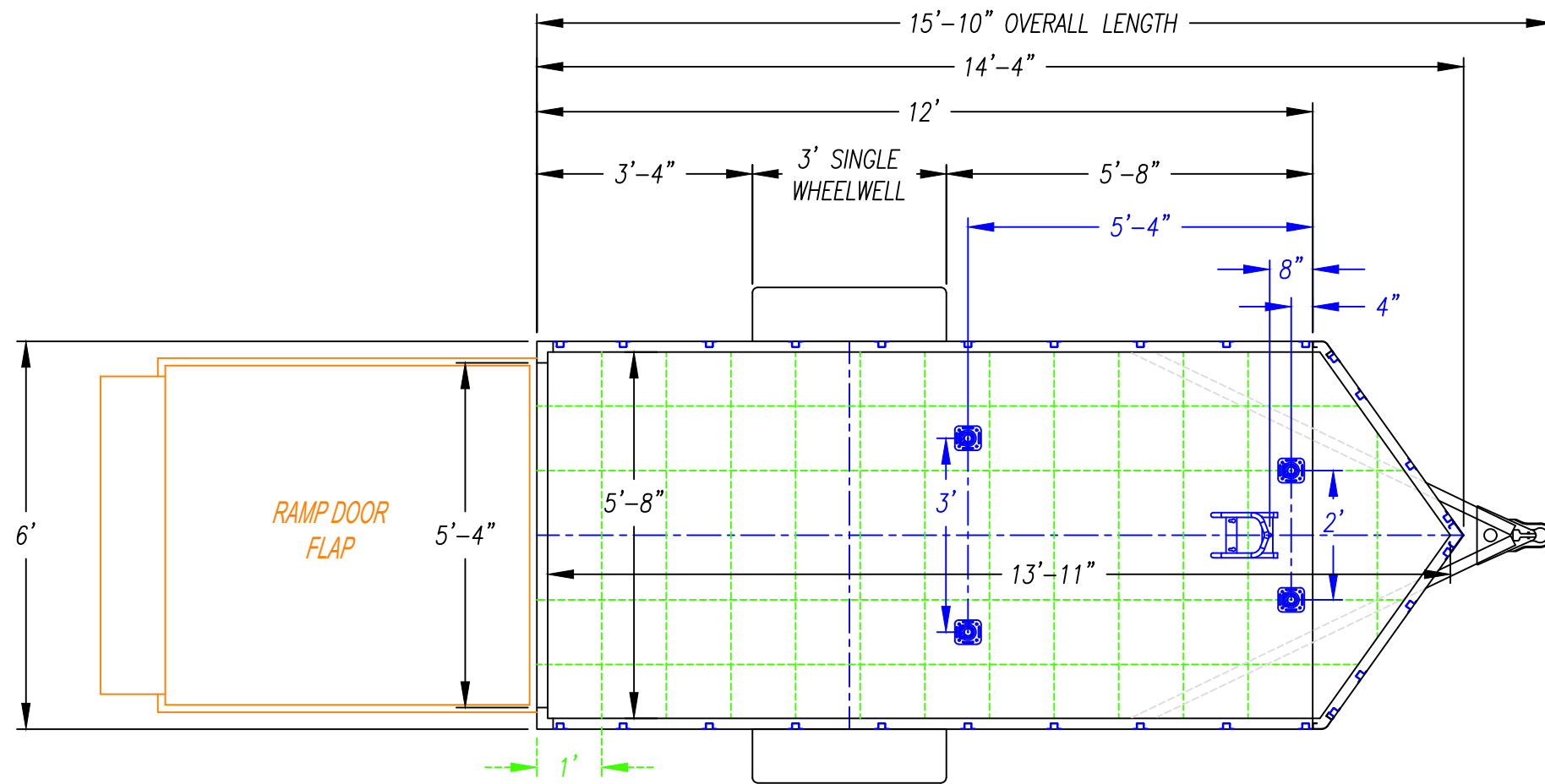

DESCRIPTION -  
XLMTV-612SA WITH DRINGS-CHOCKS

DRAWN BY - JAH

DATE - 6/13/19

THIS DOCUMENT AND THE CONCEPTS INCORPORATED IS THE PROPERTY OF UNITED TRAILERS INC. AND IS NOT TO BE USED IN WHOLE OR IN PART FOR ANY OTHER PROJECT WITHOUT WRITTEN PERMISSION OF UNITED TRAILERS INC..

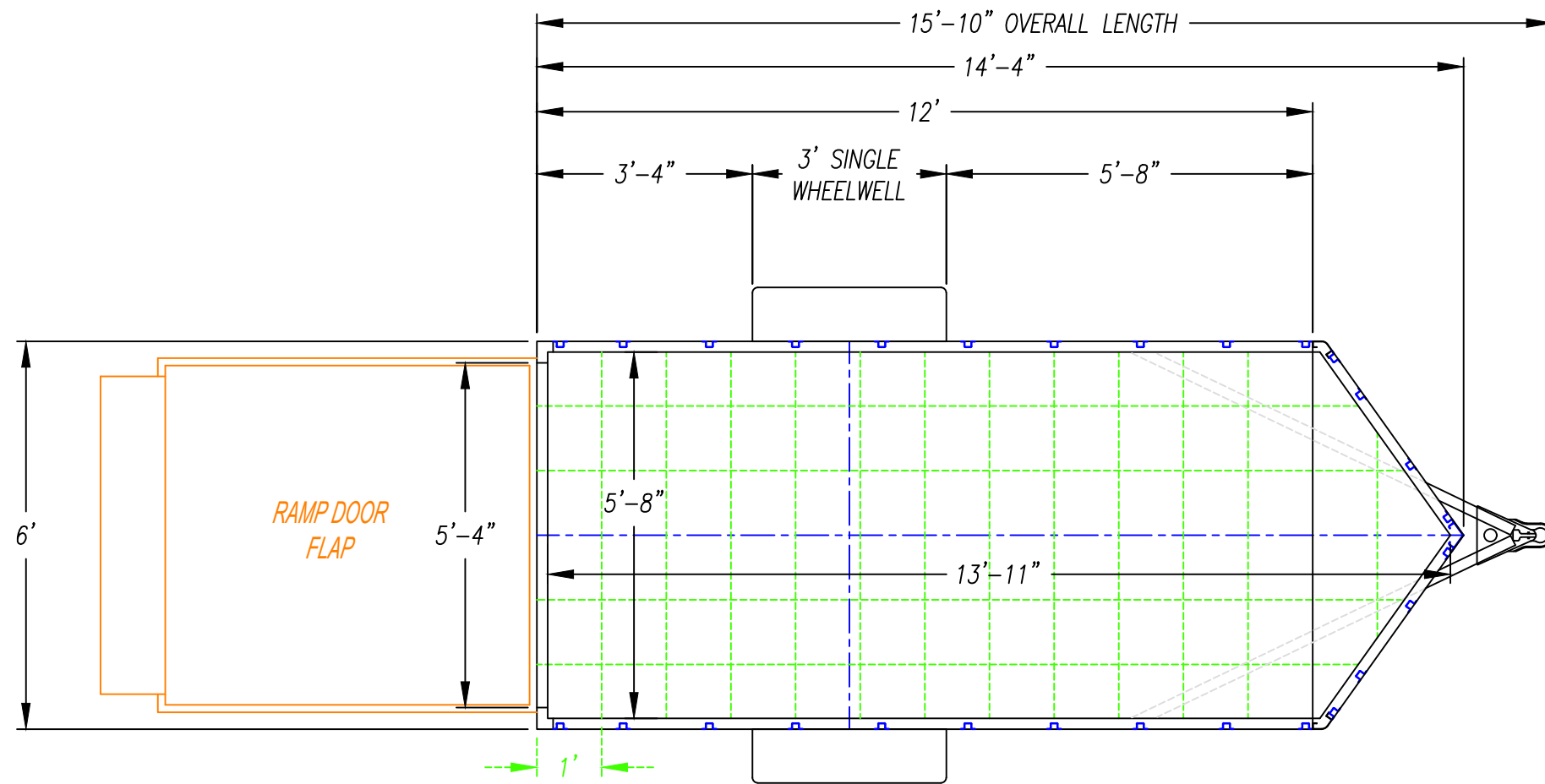

DESCRIPTION -  
XLMTV-612SA WITH NO DRINGS-CHOCKS

DRAWN BY - JAH

DATE - 6/13/19

THIS DOCUMENT AND THE CONCEPTS INCORPORATED IS THE PROPERTY OF UNITED TRAILERS INC. AND IS NOT TO BE USED IN WHOLE OR IN PART FOR ANY OTHER PROJECT WITHOUT WRITTEN PERMISSION OF UNITED TRAILERS INC..

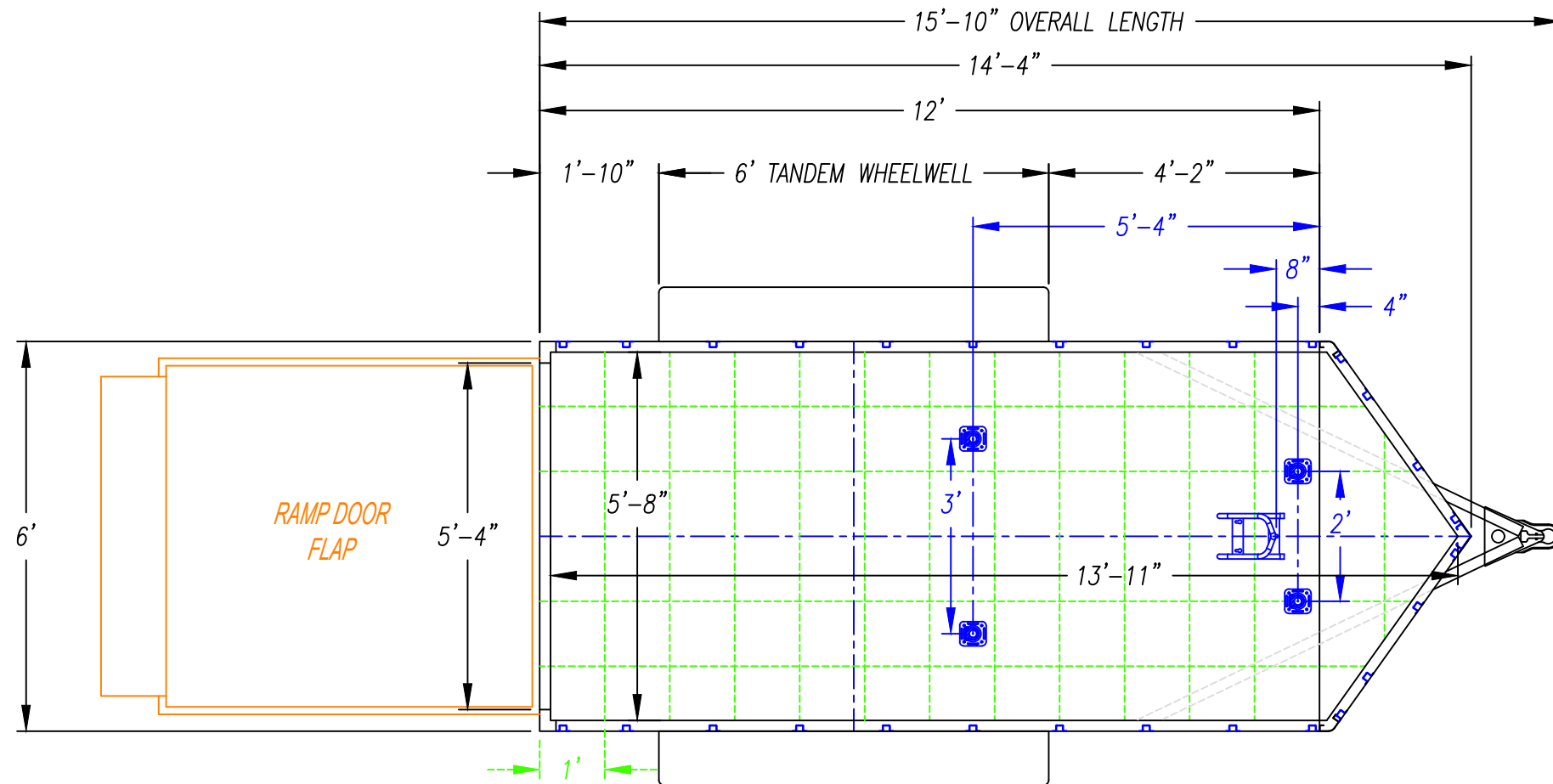

DESCRIPTION -  
XLMTV-612TA WITH DRINGS-CHOCKS

DRAWN BY - JAH

DATE - 6/13/19

THIS DOCUMENT AND THE CONCEPTS INCORPORATED IS THE PROPERTY OF UNITED TRAILERS INC. AND IS NOT TO BE USED IN WHOLE OR IN PART FOR ANY OTHER PROJECT WITHOUT WRITTEN PERMISSION OF UNITED TRAILERS INC..

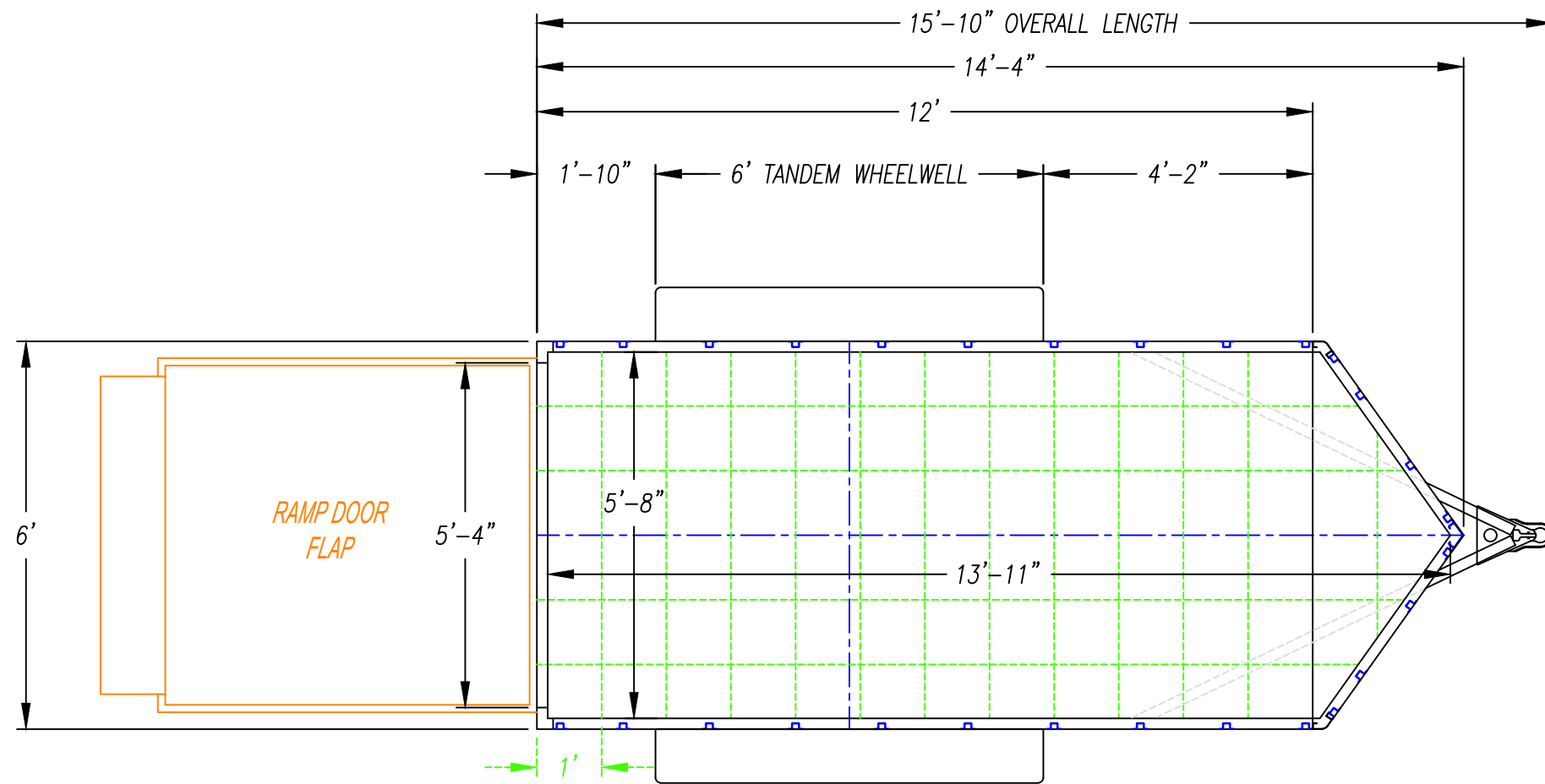

DESCRIPTION -  
XLMTV-612TA WITH NO DRINGS-CHOCKS

DRAWN BY - JAH

DATE - 6/13/19

THIS DOCUMENT AND THE CONCEPTS INCORPORATED IS THE PROPERTY OF UNITED TRAILERS INC. AND IS NOT TO BE USED IN WHOLE OR IN PART FOR ANY OTHER PROJECT WITHOUT WRITTEN PERMISSION OF UNITED TRAILERS INC..



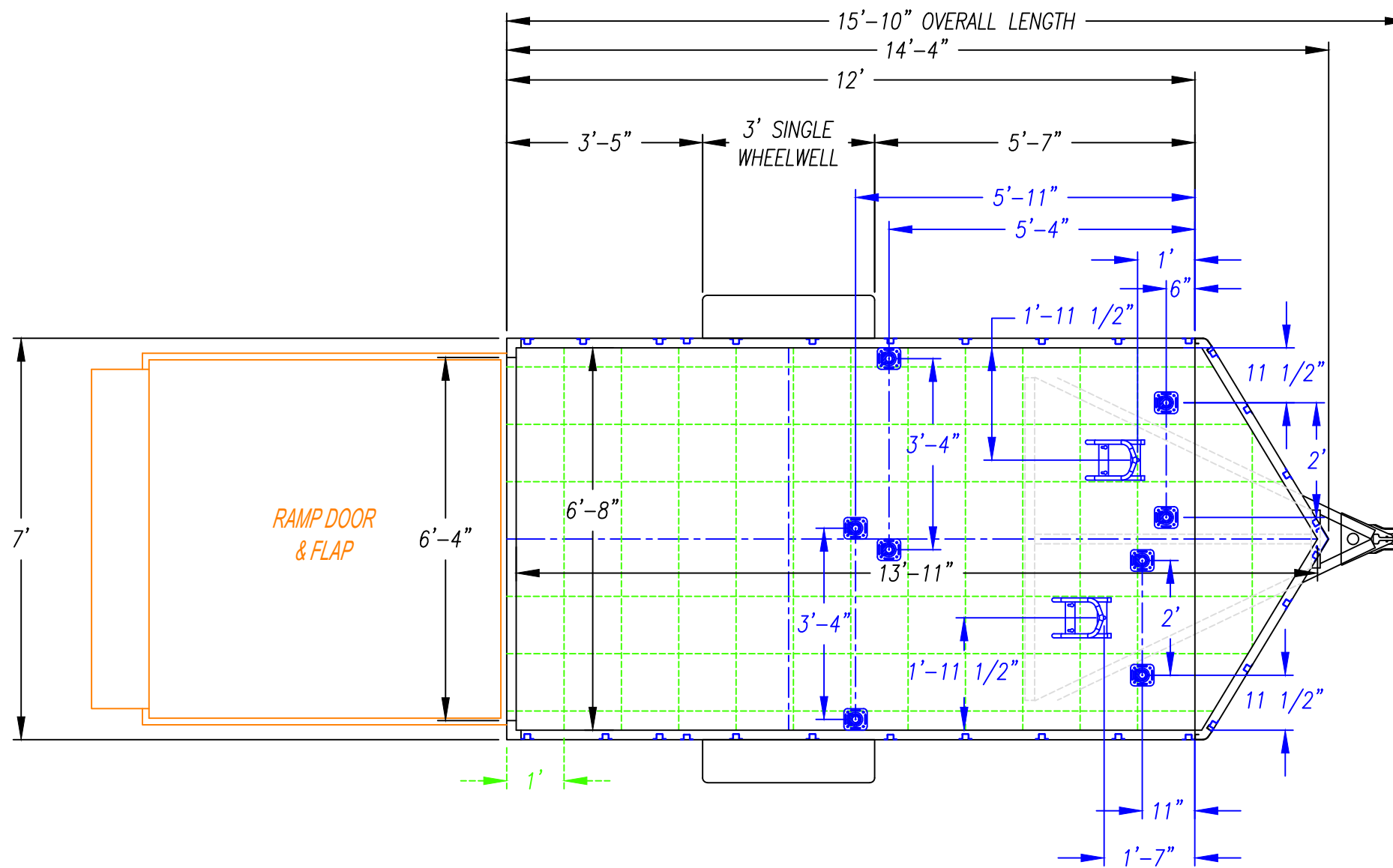

DESCRIPTION - XLMTV-712SA WITH DRINGS-CHOCKS

DRAWN BY - JAH

DATE - 6/13/19

THIS DOCUMENT AND THE CONCEPTS INCORPORATED IS THE PROPERTY OF UNITED TRAILERS INC. AND IS NOT TO BE USED IN WHOLE OR IN PART FOR ANY OTHER PROJECT WITHOUT WRITTEN PERMISSION OF UNITED TRAILERS INC..

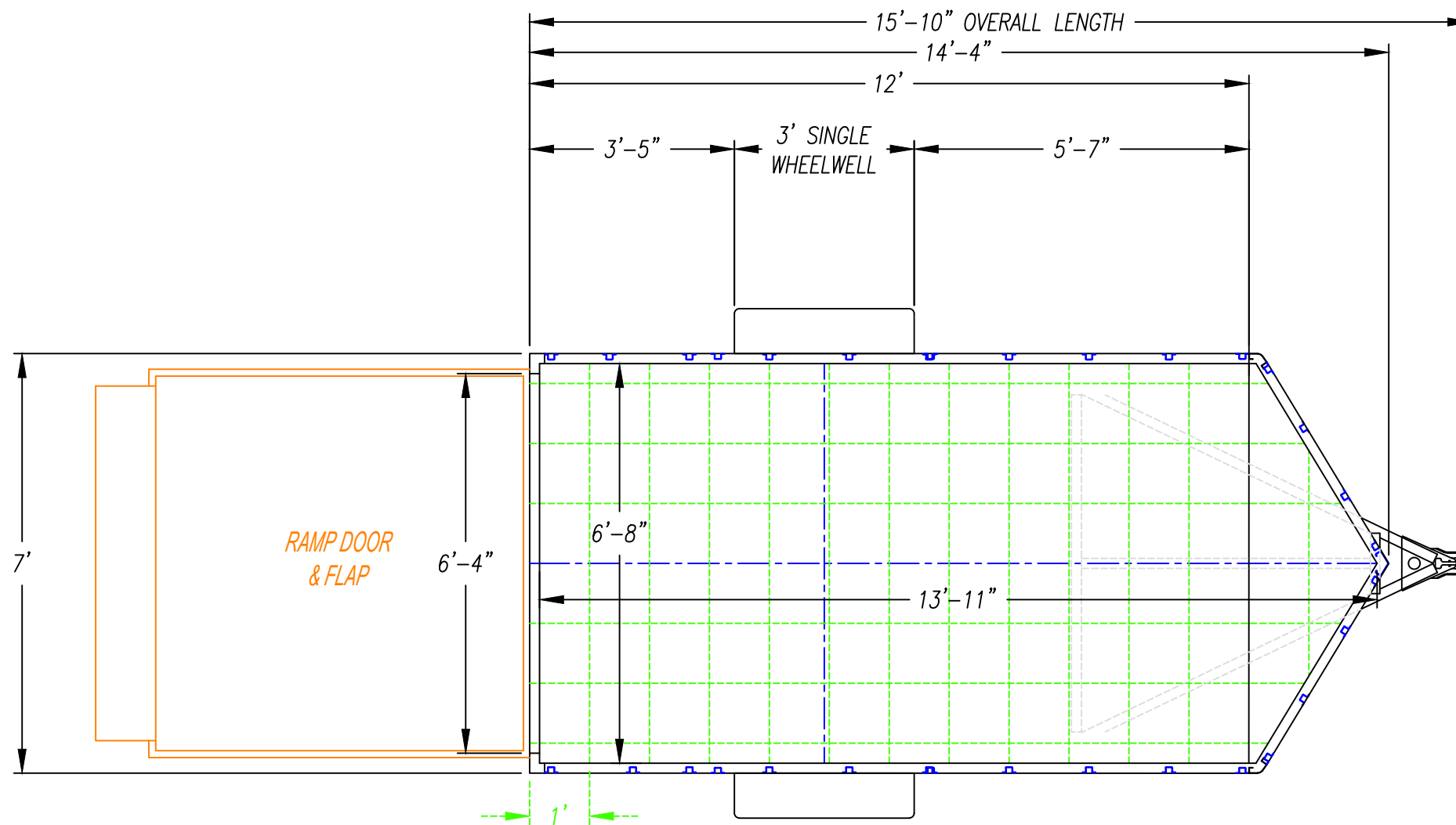

DESCRIPTION -  
XLMTV-712SA WITH NO DRINGS-CHOCKS

DRAWN BY - JAH

DATE - 6/13/19

THIS DOCUMENT AND THE CONCEPTS INCORPORATED IS THE PROPERTY OF UNITED TRAILERS INC. AND IS NOT TO BE USED IN WHOLE OR IN PART FOR ANY OTHER PROJECT WITHOUT WRITTEN PERMISSION OF UNITED TRAILERS INC..

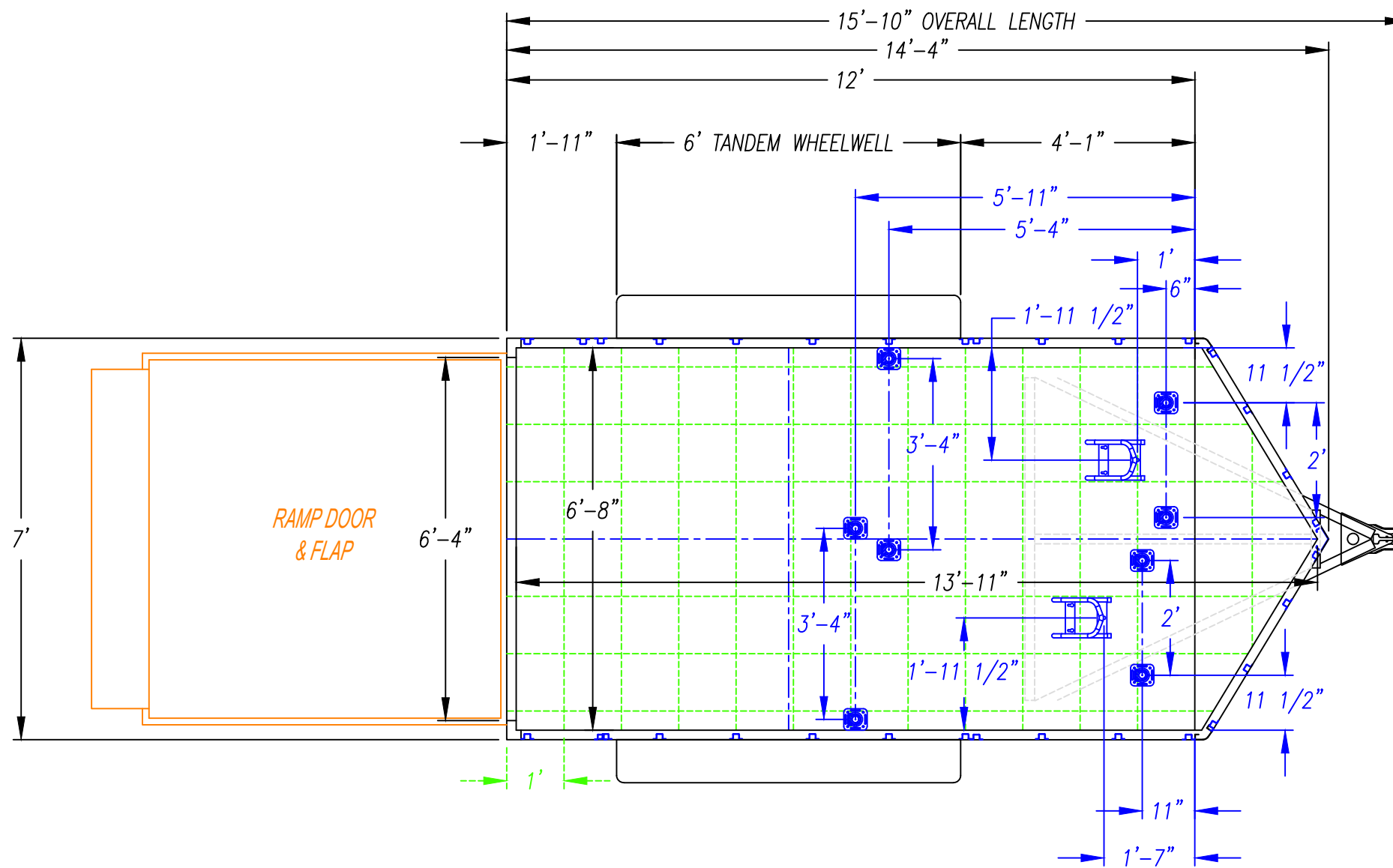

DESCRIPTION -  
 XLMTV-712TA WITH DRINGS-CHOCKS

DRAWN BY - JAH

DATE - 6/13/19

THIS DOCUMENT AND THE CONCEPTS INCORPORATED IS THE PROPERTY OF UNITED TRAILERS INC. AND IS NOT TO BE USED IN WHOLE OR IN PART FOR ANY OTHER PROJECT WITHOUT WRITTEN PERMISSION OF UNITED TRAILERS INC..

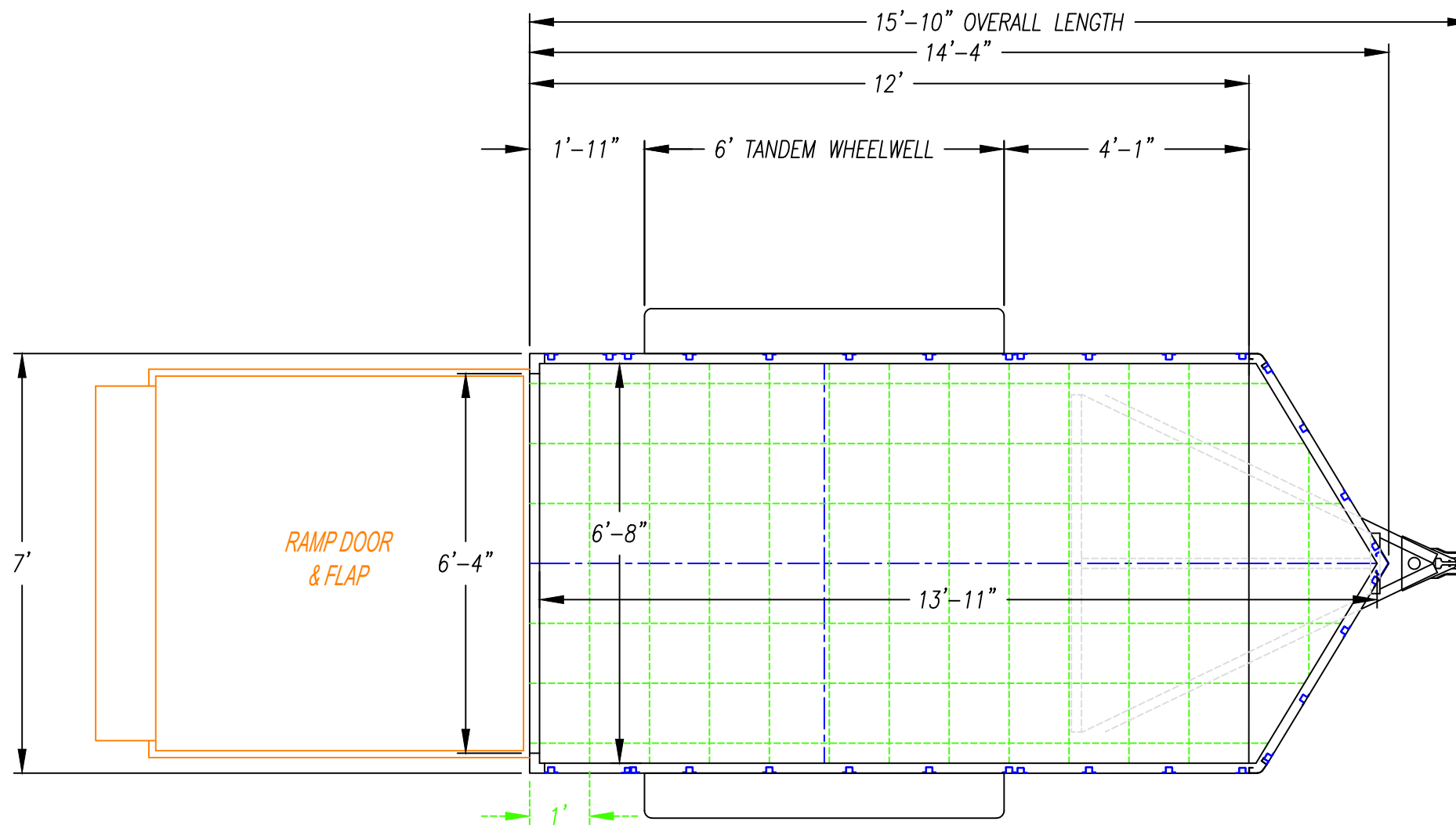

DESCRIPTION -  
XLMTV-712TA WITH NO DRINGS-CHOCKS

DRAWN BY - JAH

DATE - 6/13/19

THIS DOCUMENT AND THE CONCEPTS INCORPORATED IS THE PROPERTY OF UNITED TRAILERS INC. AND IS NOT TO BE USED IN WHOLE OR IN PART FOR ANY OTHER PROJECT WITHOUT WRITTEN PERMISSION OF UNITED TRAILERS INC..

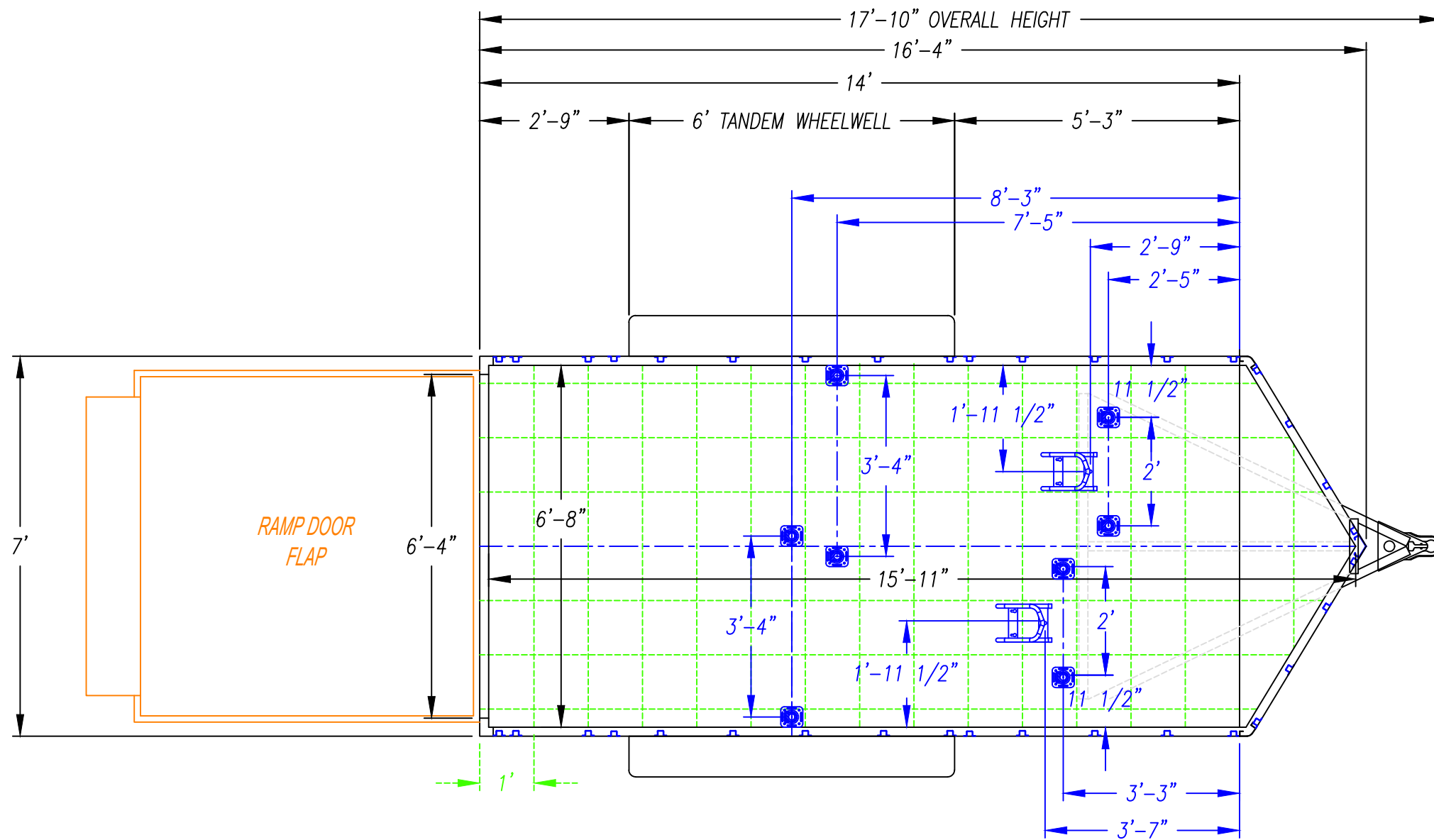

DESCRIPTION -  
XLMTV-714TA WITH DRINGS-CHOCKS

DRAWN BY - JAH

DATE - 6/13/19

THIS DOCUMENT AND THE CONCEPTS INCORPORATED IS THE PROPERTY OF UNITED TRAILERS INC. AND IS NOT TO BE USED IN WHOLE OR IN PART FOR ANY OTHER PROJECT WITHOUT WRITTEN PERMISSION OF UNITED TRAILERS INC..

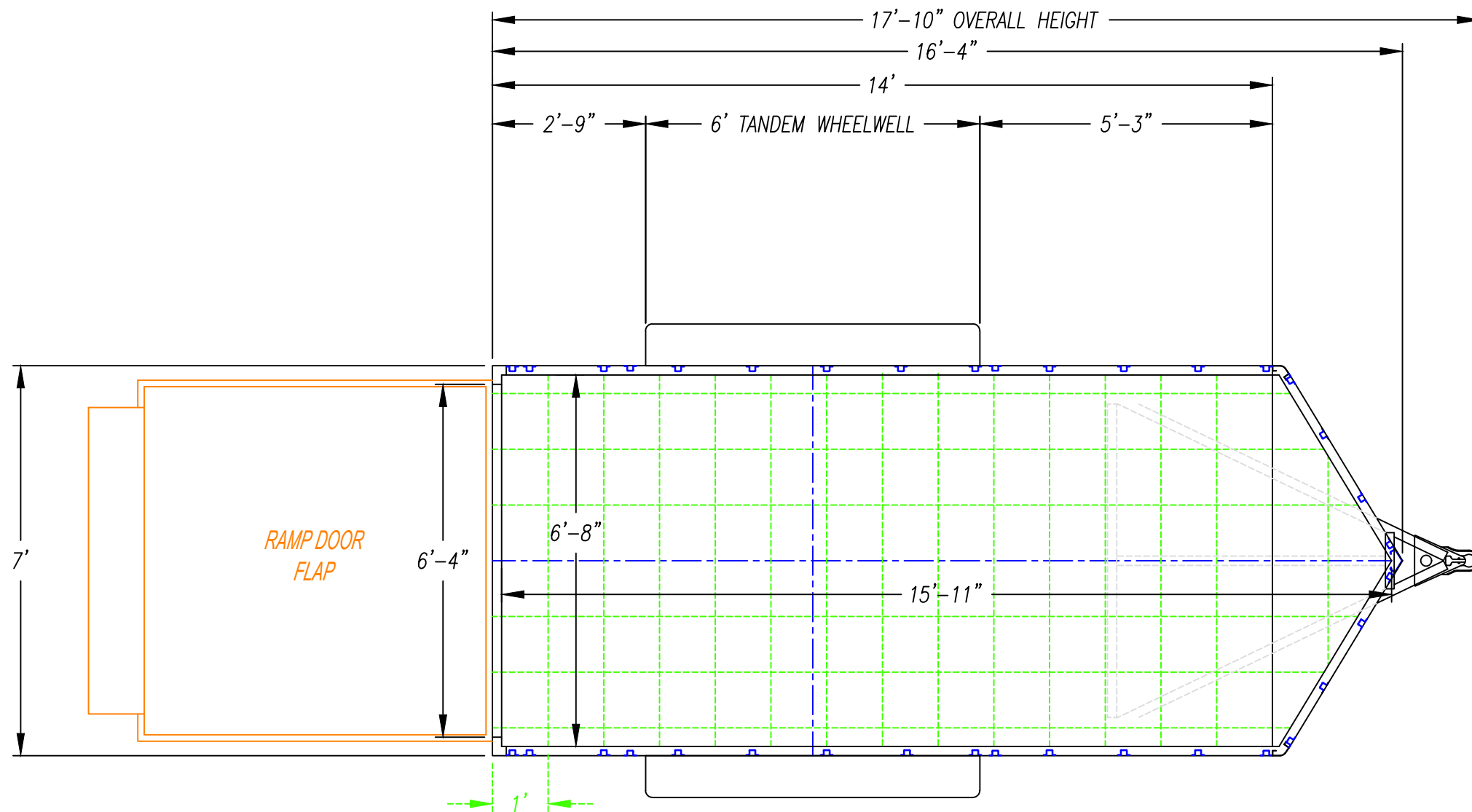

DESCRIPTION -  
 XLMTV-714TA WITH NO DRINGS-CHOCKS

DRAWN BY - JAH

DATE - 6/13/19

THIS DOCUMENT AND THE CONCEPTS INCORPORATED IS THE PROPERTY OF UNITED TRAILERS INC. AND IS NOT TO BE USED IN WHOLE OR IN PART FOR ANY OTHER PROJECT WITHOUT WRITTEN PERMISSION OF UNITED TRAILERS INC..

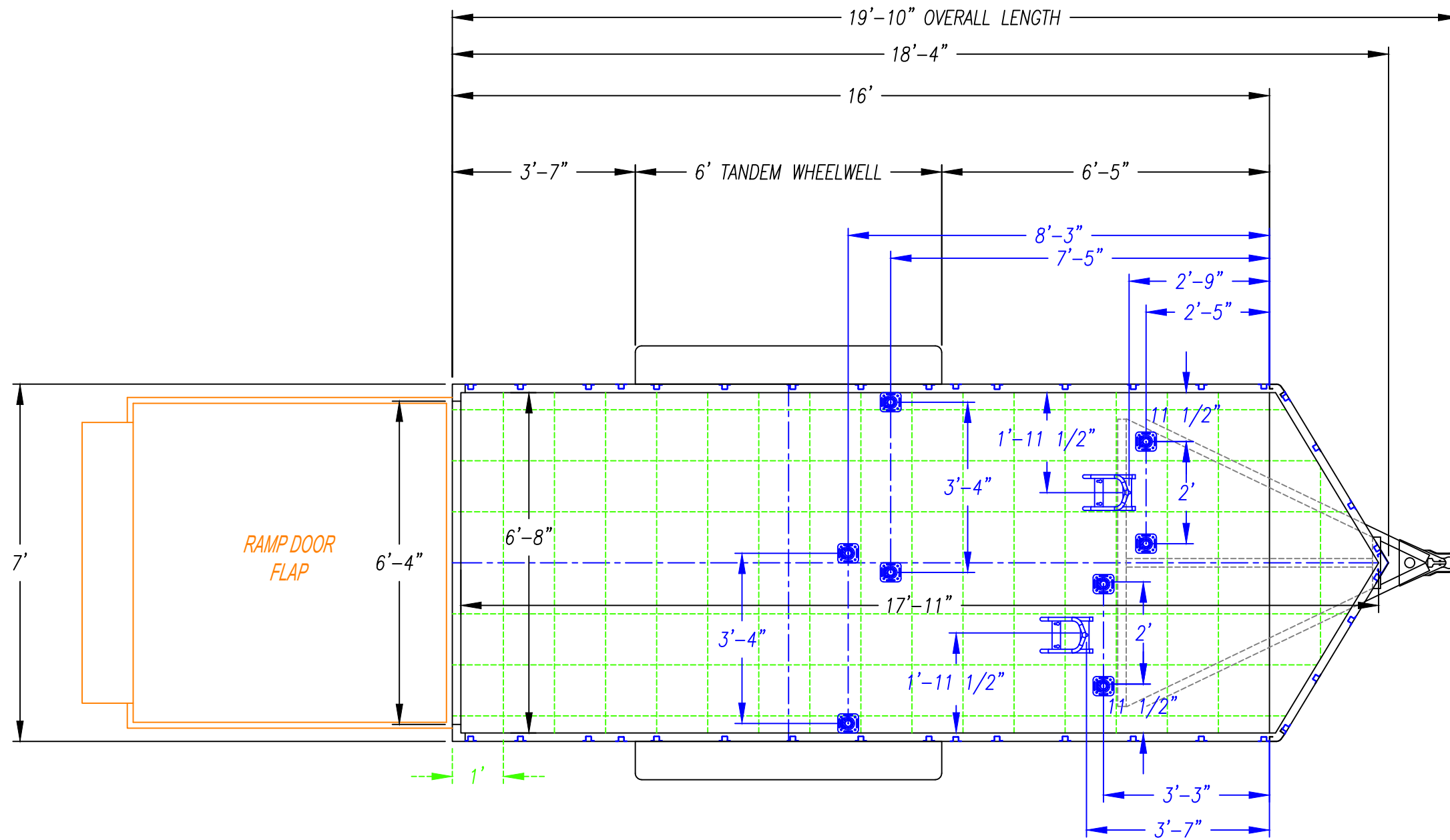

DESCRIPTION - XLMTV-716TA WITH DRINGS-CHOCKS

DRAWN BY - JAH

DATE - 6/13/19

THIS DOCUMENT AND THE CONCEPTS INCORPORATED IS THE PROPERTY OF UNITED TRAILERS INC. AND IS NOT TO BE USED IN WHOLE OR IN PART FOR ANY OTHER PROJECT WITHOUT WRITTEN PERMISSION OF UNITED TRAILERS INC..

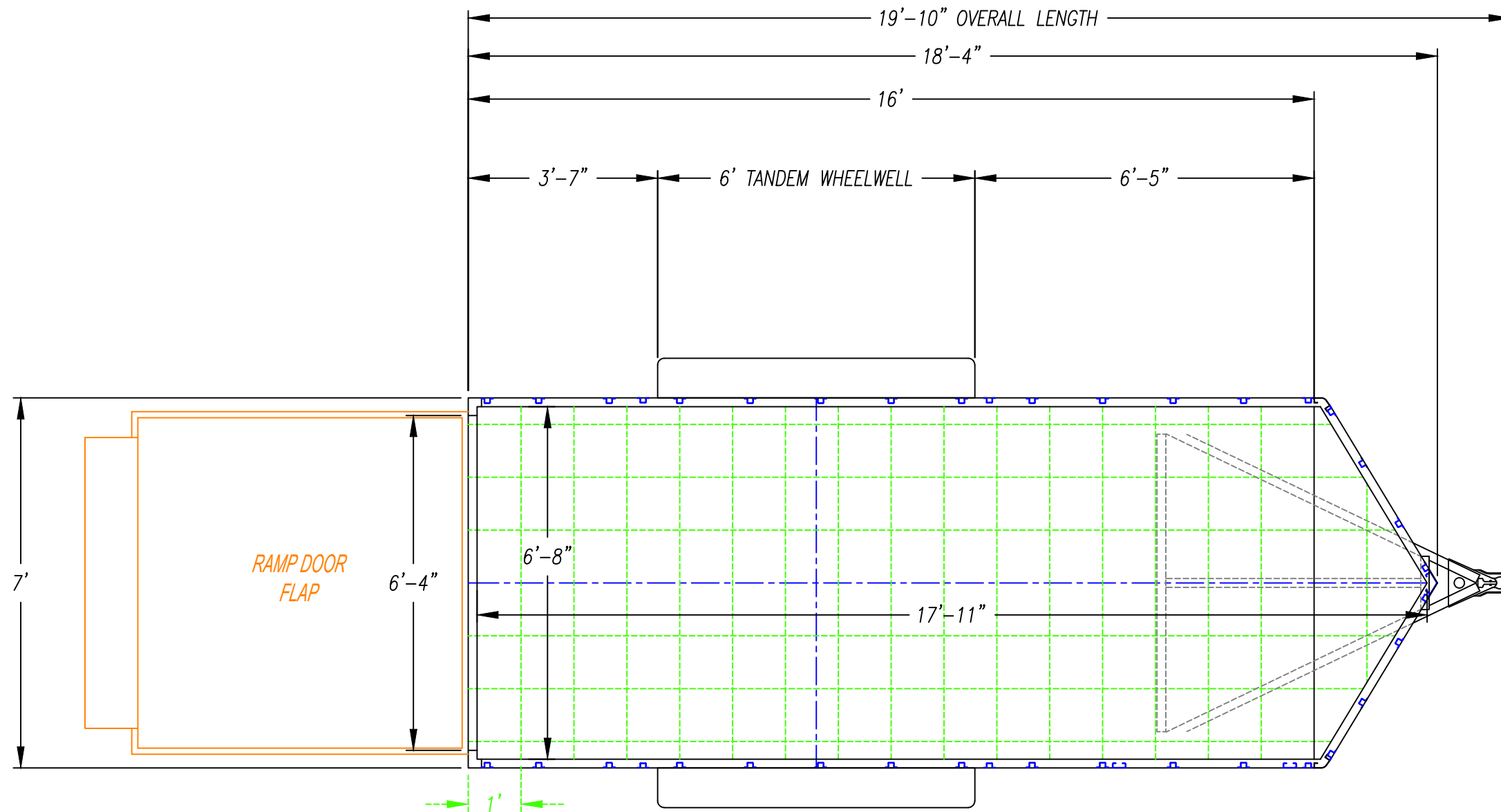

DESCRIPTION -  
XLMTV-716TA WITH NO DRINGS-CHOCKS

DRAWN BY - JAH

DATE - 6/13/19

THIS DOCUMENT AND THE CONCEPTS INCORPORATED IS THE PROPERTY OF UNITED TRAILERS INC. AND IS NOT TO BE USED IN WHOLE OR IN PART FOR ANY OTHER PROJECT WITHOUT WRITTEN PERMISSION OF UNITED TRAILERS INC..